

# Sinexcel PCS for Storage

## 30kw-150Kw

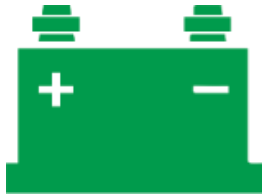

**Battery-only  
PCS**

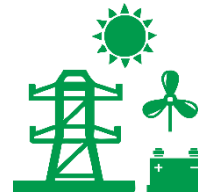

**PV + Battery  
Hybrid PCS**

# PCS for Grid-tied Applications

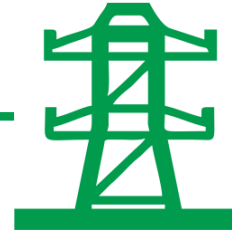

## Battery-only Power Converter for Residential Community

System Power Range	30Kw
Battery Energy	30-800Kwh
Battery Voltage Range	250-800V

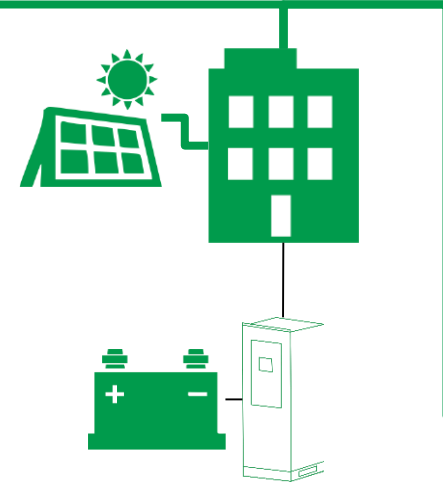
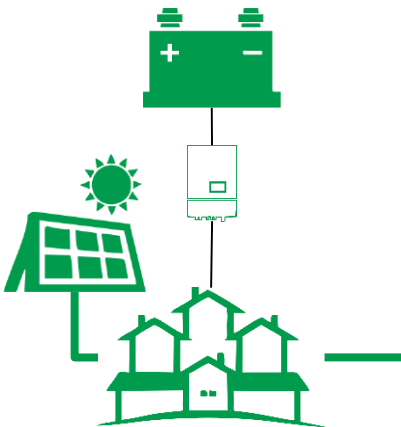

## Battery-only Power Converter for Commercial Application

System Power Range	50-150Kw
Battery Energy	30-2000Kwh
Battery Voltage Range	500-800V

## Hybrid Power Converter for Commercial Application

System Power Range	50-100Kw
PV Power Range	50-100Kwp
PV Voltage Range	460-900V(1000V)
Battery Energy	50-4000Kwh
Battery Voltage Range	250-520V

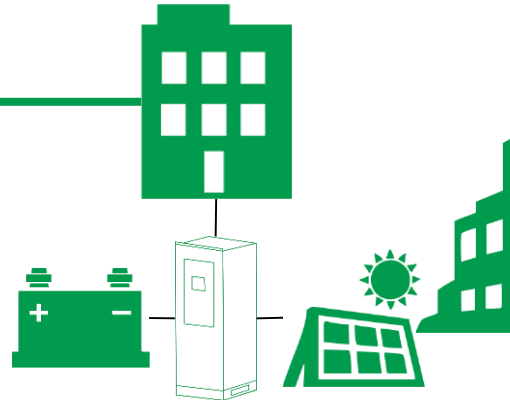

## Battery-only Power Converter for Industrial Application

System Power Range	50-500Kw
Battery Energy	75-4000Kwh
Battery Voltage Range	500-800 /630-900
Battery Input Numbers	1/4/8

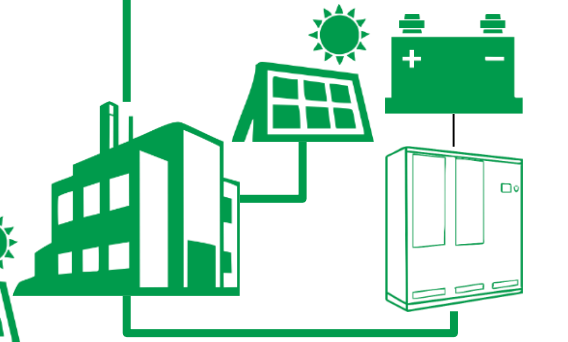

# PCS for Off-grid Applications

## Battery-only Power Converter

System Power Range	30-150Kw
Battery Energy	30-4000Kwh
Battery Voltage Range	500-800V

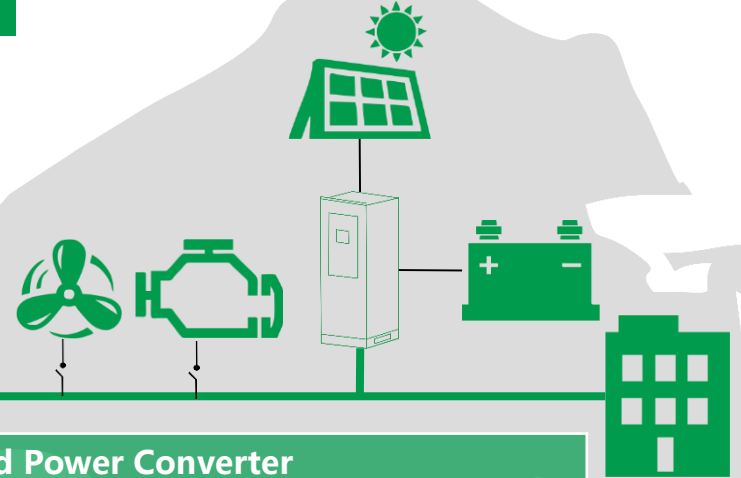
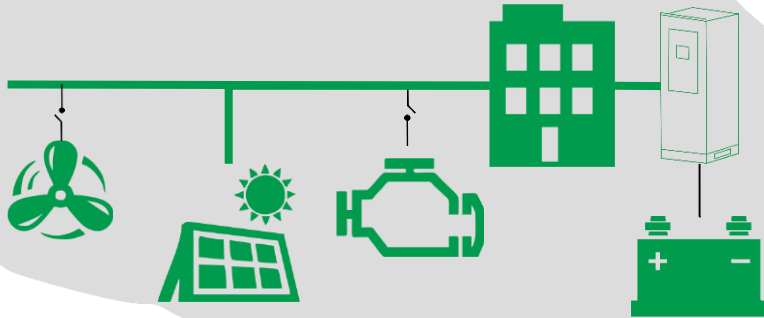

## Hybrid Power Converter

System Power Range	50-100Kw
PV Power Range	50-100Kwp
PV Voltage Range	460-900V(1000V)
Battery Energy	50-4000Kwh
Battery Voltage Range	250-520V

# 30Kw Wall-mount Storage Inverter



Designed for North America



High Efficiency  
Up to 97.5%

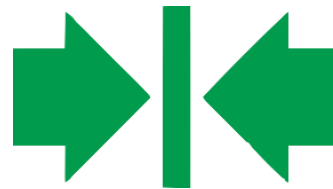

Compact Size  
470\*660\*176mm

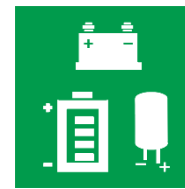

Support Various  
Battery



Full Protection

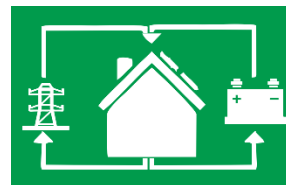

On-grid & Off-grid



Wide DC Voltage  
250-800Vdc

# 50/100Kw Hybrid Storage Converter & 50/100/150Kw Storage Inverter



**Modular Design**



**High Efficiency  
Up to 96.1%**



**Flexible  
Configuration**



**Fast response time**



**Reliable  
Performance**



9540



1741
1547C
C22.2

**Certified for North America**

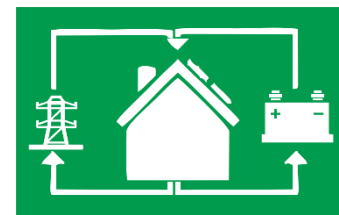

**On-grid & Off-grid**

# System Diagram for Hybrid Bi-directional PCS

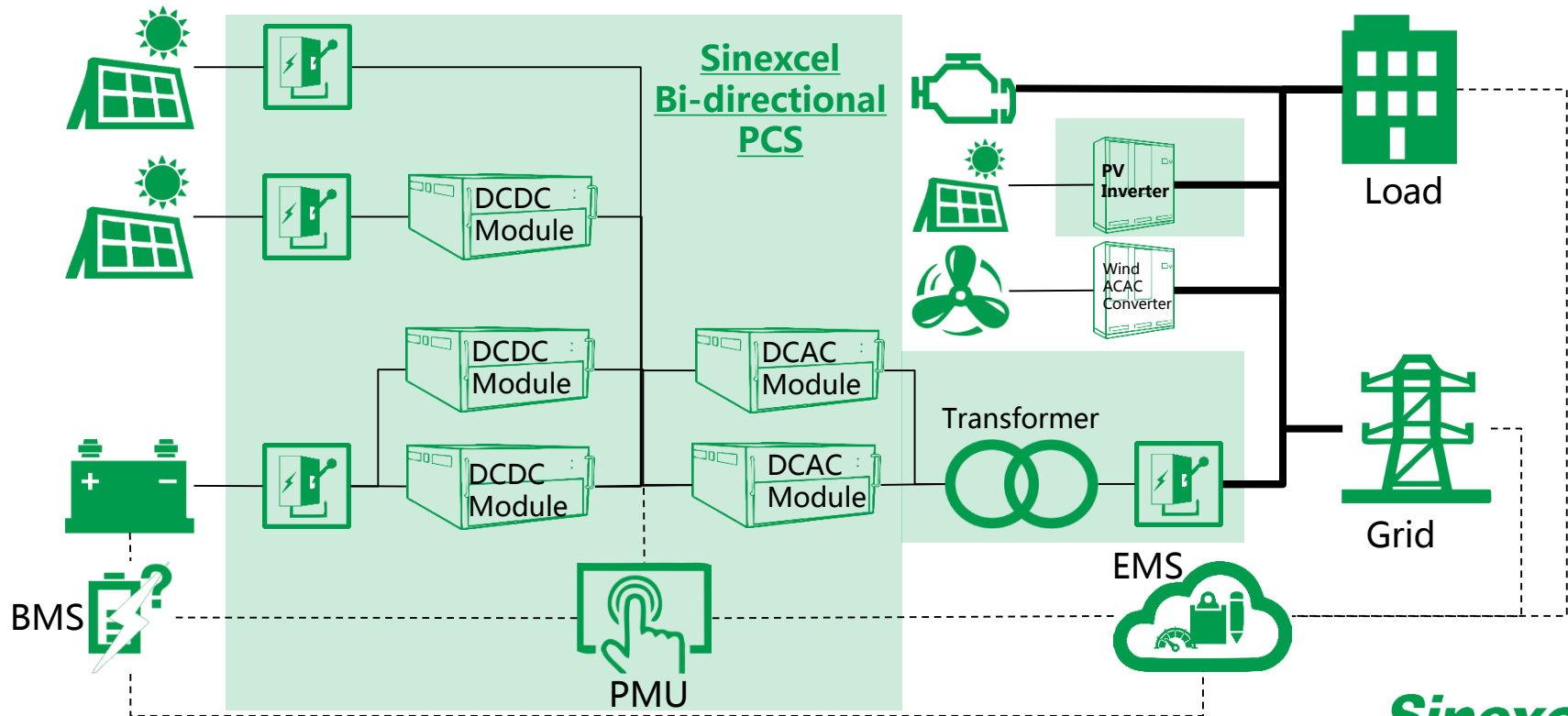

# System Diagram for Storage-only Bi-directional PCS

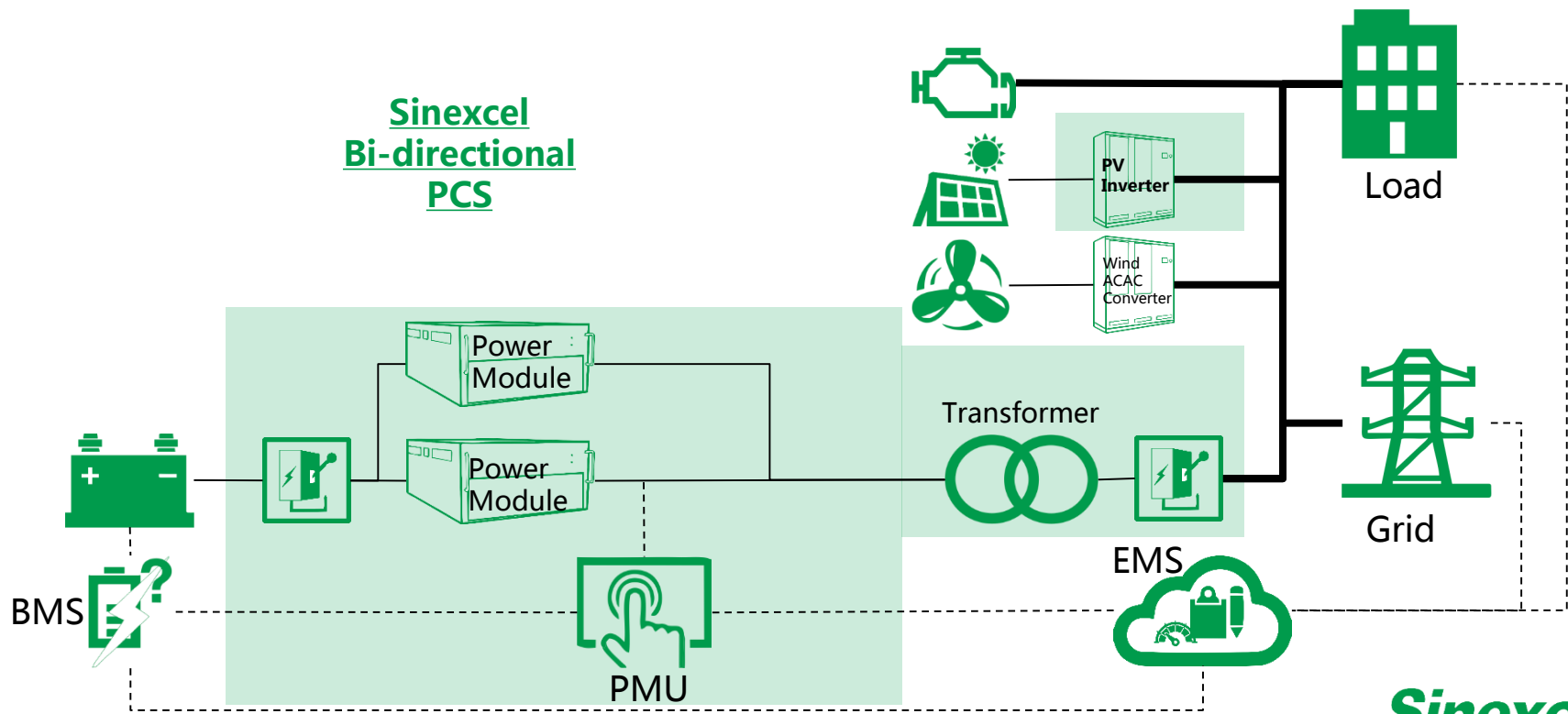

# 50-150Kw

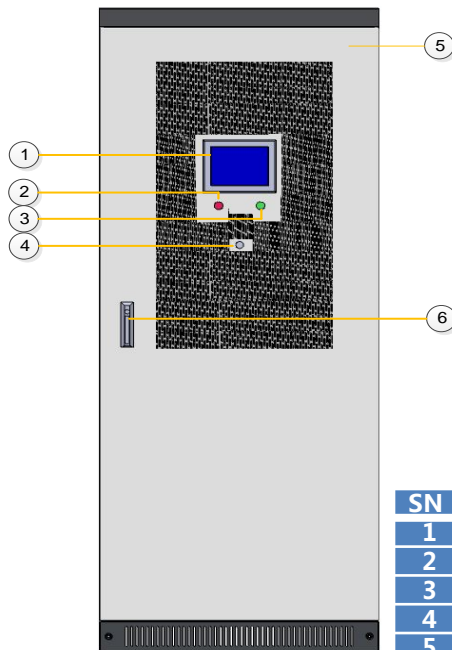
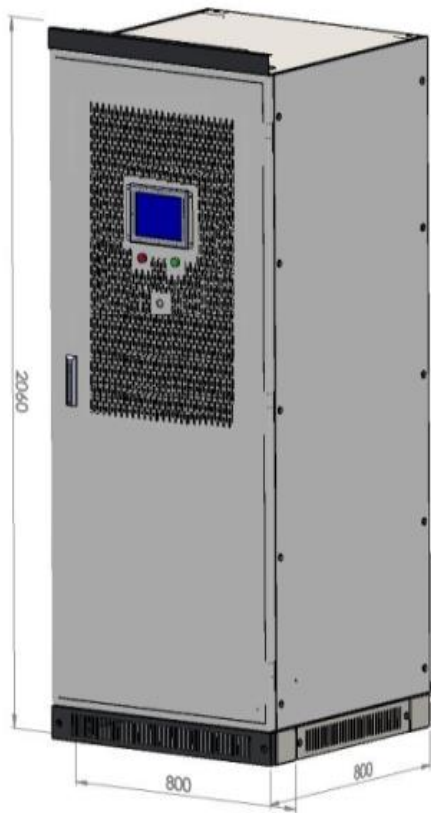

SN	Description
1	Touch Screen
2	Failure Indicator
3	Normal Indicator
4	EPO Button
5	Model Label
6	Locker

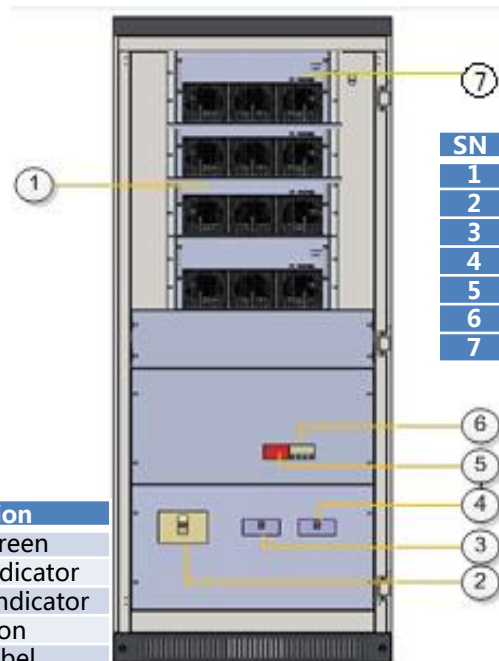

SN	Description
1	AC/DC Converter
2	DC breaker
3	AC breaker (Load)
4	AC breaker (Grid)
5	AC SPD
6	SPD breaker
7	DC/DC Converter



# Find Out Partner

- US Local Partner



18 Culnen Drive, Branchburg, NJ 08876  
[www.atlanticces.com](http://www.atlanticces.com) 888.900.1581 sales@atlanticces.com